

Varenummer: 4395000751  
Beskrivelse: Rota-fix spændelement F75x115  
Rustfast stål

## Mål

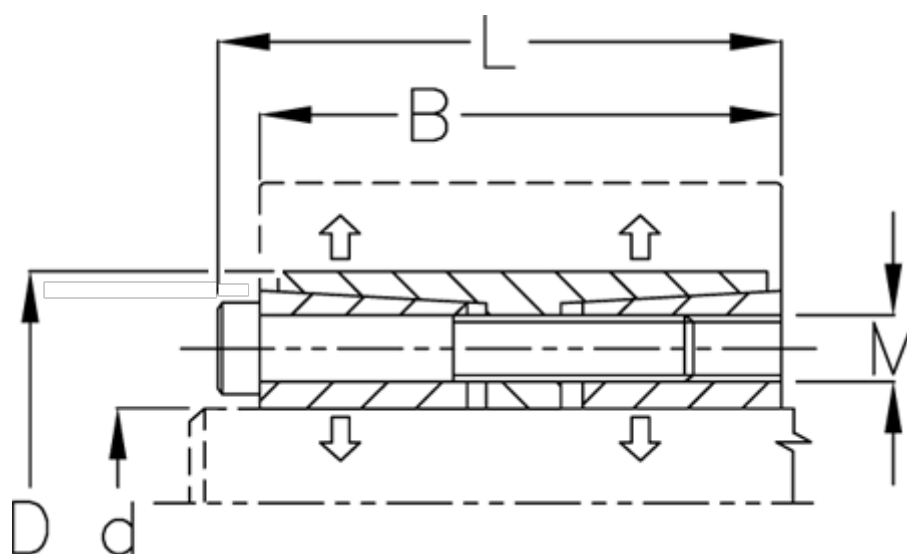

B mm	= 80
d H8 mm	= 75
D mm	= 115
F kN aksialkraft	= 179.0
L mm	= 90
M mm	= M10
Overfladeruhed	= R? ? 3.2 $\mu$ m
P N/mm <sup>2</sup> fladetryk på aksel/nav	= 35

T Nm drejningsmoment	= 6710
Tolerance	= Aksel h8, Nav H8
Ts Nm boltetilspændingsmoment	= 58.0